

Approved for Issue - 4 June 2008

iBase 22 UNO – 1300 x 800

Robust, Low Profile & Designed for fitting onto wooden floors, this 22mm thick GRP wet room system replaces part of the floor, creating a gradient leading to a waste outlet. Supplied with AquaeSEAL UNO Waterproof Tanking, this 'ALL-INCLUSIVE KIT' is offered to suit a tile floor finish

E&OE



PRODUCT CHARACTERISTICS

- GRP based hard Shower Base c/w Flat Underside, 17mm Gradients leading to Outlet with Factory Fit Collar to suit Waste Kit
- Self Supporting Waste & Trap Assembly with Horizontal outlet pipe (DIN 50mm)(Vertical available- special order)
- Stainless Steel Outlet Grate with Height Adjustment
- INCLUDES a UNO Installation Sealing Kit comprising Waterproofing Sealant & Joint Sealing Tape

APPLICATIONS

iBase 22 UNO kits are suitable to construct & seal the floor of a shower area within a wet room type bathroom. Suits:

- En-Suites – small bathrooms where space efficiency is at a premium
- High End Designer Bathrooms – Large sizes add to the feeling of space within a shower area
- Wheelchair & Special Needs– Bathrooms where accessibility is an essential element of the design
- Refurbishments & New Build
- Floor Structures – Designed for Board over Wooden Joist

TECHNICAL DATA – DIMENSIONS & SIZE

- Sizes : 1300 x 800
- Profile : Low Profile 22mm at the outer edge
- Gradient : 17mm generally, dependant upon point of measurement
- Waste & Trap : 2" UK (c/w 1½ ABS Converter)
- Waterproofing Kit : AquaeSEAL – UNO 5m² – See Data Sheet

TECHNICAL DATA – MATERIAL

- Shower Base : GRP, 22mm Thick, with a 17mm Gradient leading to the Outlet
- Grating : 5mm thick 304 Stainless Steel Plate
- Grating : Height Adjustment, 6mm to 26mm for ceramic tiles
- Waste & Trap : ABS Solvent Weld 126mm Deep, designed for tiles
- Outlet : Location is Model Dependant – Off-set. See Drawing
- Weight Loading : Will support in excess of 250kg
- Gradient : 17mm Gradient runs in all directions across the length or width of the base
- Waterproofing Kit : 1x AquaeSEAL RP 6 k.g. PolyTub covering approx. 5m² – See Data Sheet
 : 1x Roll AquaeSEAL FLEXI JST 5m long – See Data Sheet

Approved for Issue - 4 June 2008

TECHNICAL DATA – OPTIONS

- This model is designed for Tiles, so contact us for the following options
 - : Grating for Vinyl Floors (usually Commercial, Industrial & Institutional Projects)
 - : Pumped Drainage (when gravity drainage is not available)
 - : Alternative Waterproofing
 - : Undertile Heating

CAPACITY

- Waste & Trap : Horizontal (max 22Ltrs/Min). Call us to confirm the latest Specification

DISPOSAL

- Packaging : To be disposed of according to local bylaws.

INSTALLATION INSTRUCTIONS

- Separate Sheet : Included in Package

PACKAGING

- Base : Protective Corners & Shrunk Polywrap
- Waste & Trap : Cardboard Box to suit all ancillaries
- Waterproofing : Cardboard Outer Box with PolyTub of AquaeSEAL Waterproofing & JST

CONTENTS

Supplied in 3x Packages (product dependant)

- : Shower Base
- : Installation Instructions
- : Waste & Trap – Horizontal / Vertical
- : Stainless Steel Grating
- : AquaeSEAL UNO Waterproofing Kit

Range	Size	ART No.
iBase 22 UNO	1300 x 800, OFF-SET Outlet, Horiz Waste, Install Kit	099.00124

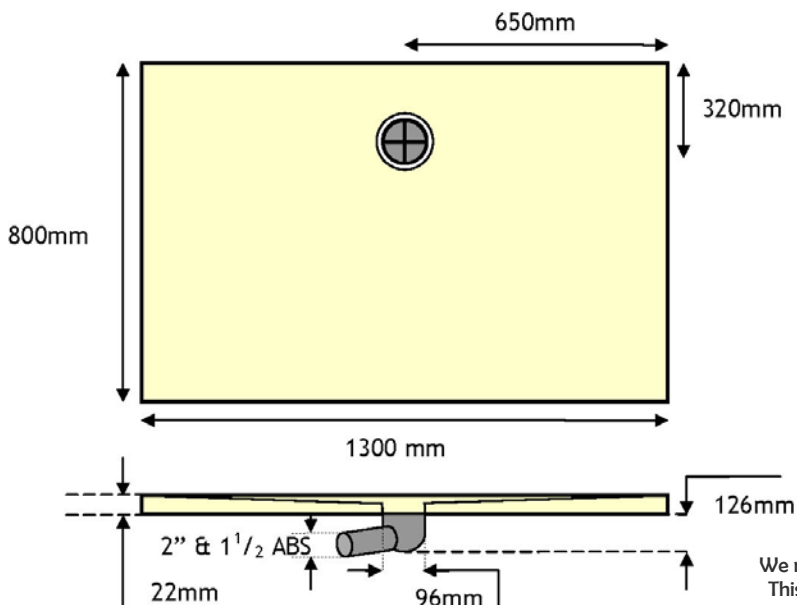

E&OE
 We reserve the right to alter & amend specifications without prior notice
 This is not a specification document & does not guarantee performance
 © Bathroom Engineering™ June 08